

GREATER HAMILTON SAFETY COUNCIL

RIGGING AND LIFTING

By

Dennis Gonzalez

Of

Overhead Crane Training and Consulting

HITCHING AND SLING LOADING
CONSIDERATIONS

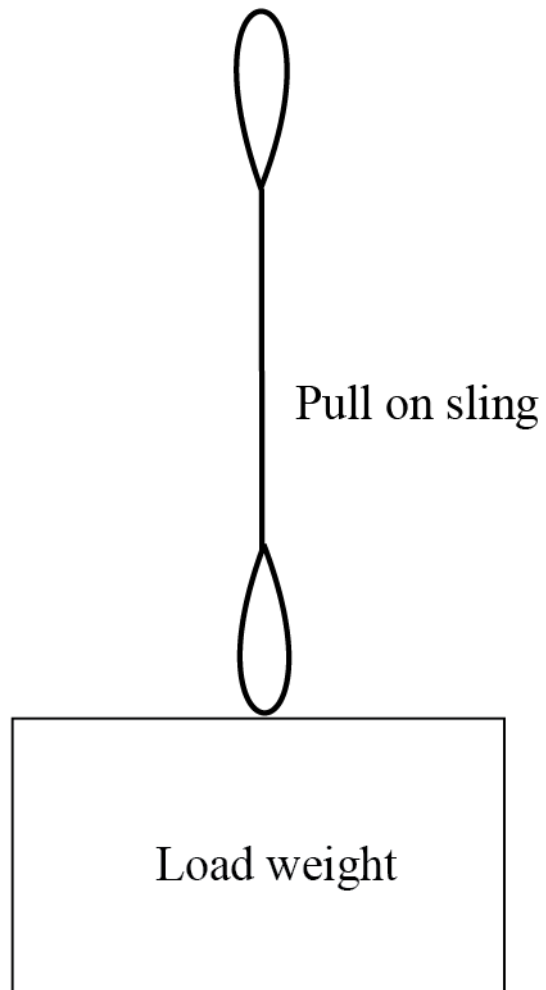

HITCHING AND SLING LOADING

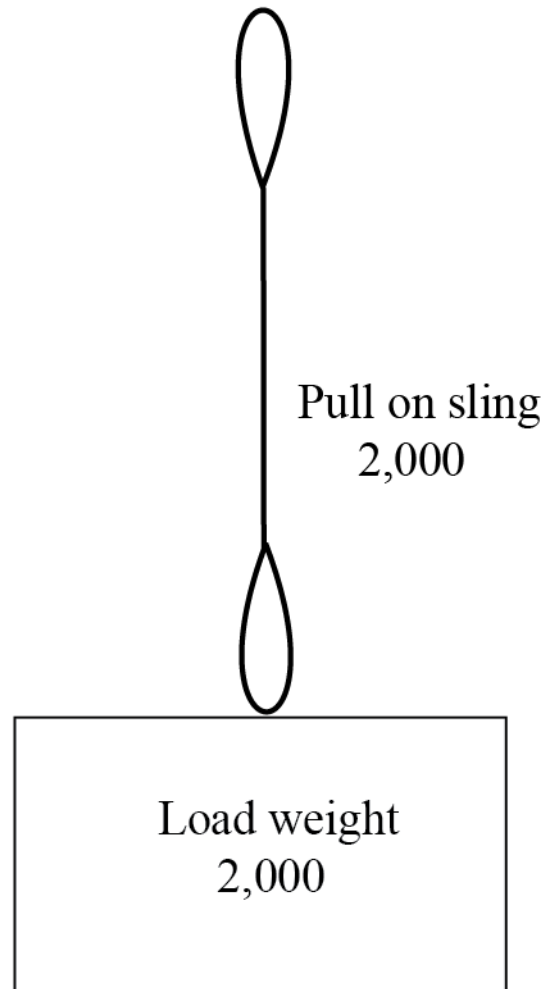

HITCHING CONFIGURATION AND SLING LOADING CONSIDERATIONS

CHOKER HITCH

The choker hitch provides a non complicated method for lifting a load. It also cinches the load which allows a good grip. The sling is bent at a substantial angle at the loop to body intersection, this angle requires the sling to be de-rated. The sling must be de-rated by 25%.

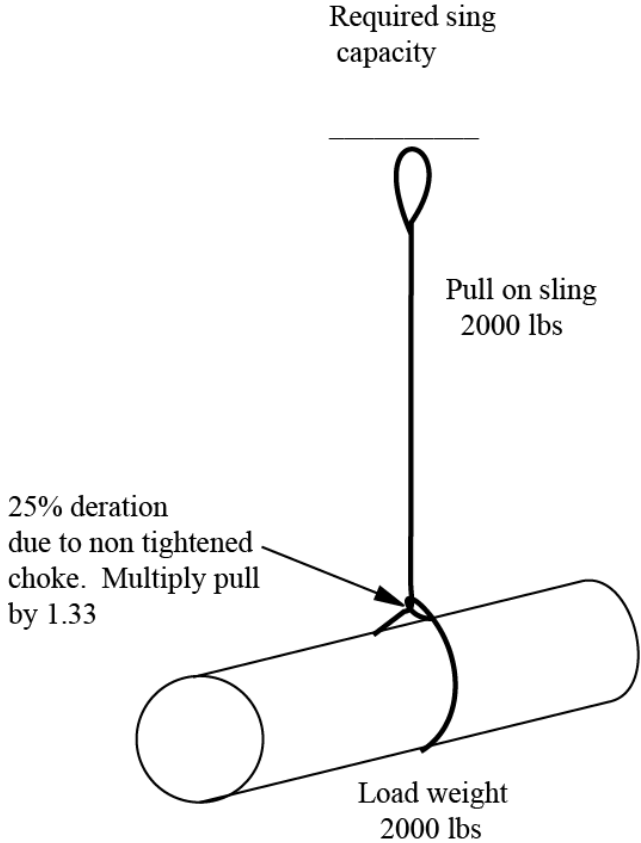

HITCHING AND SLING LOADING

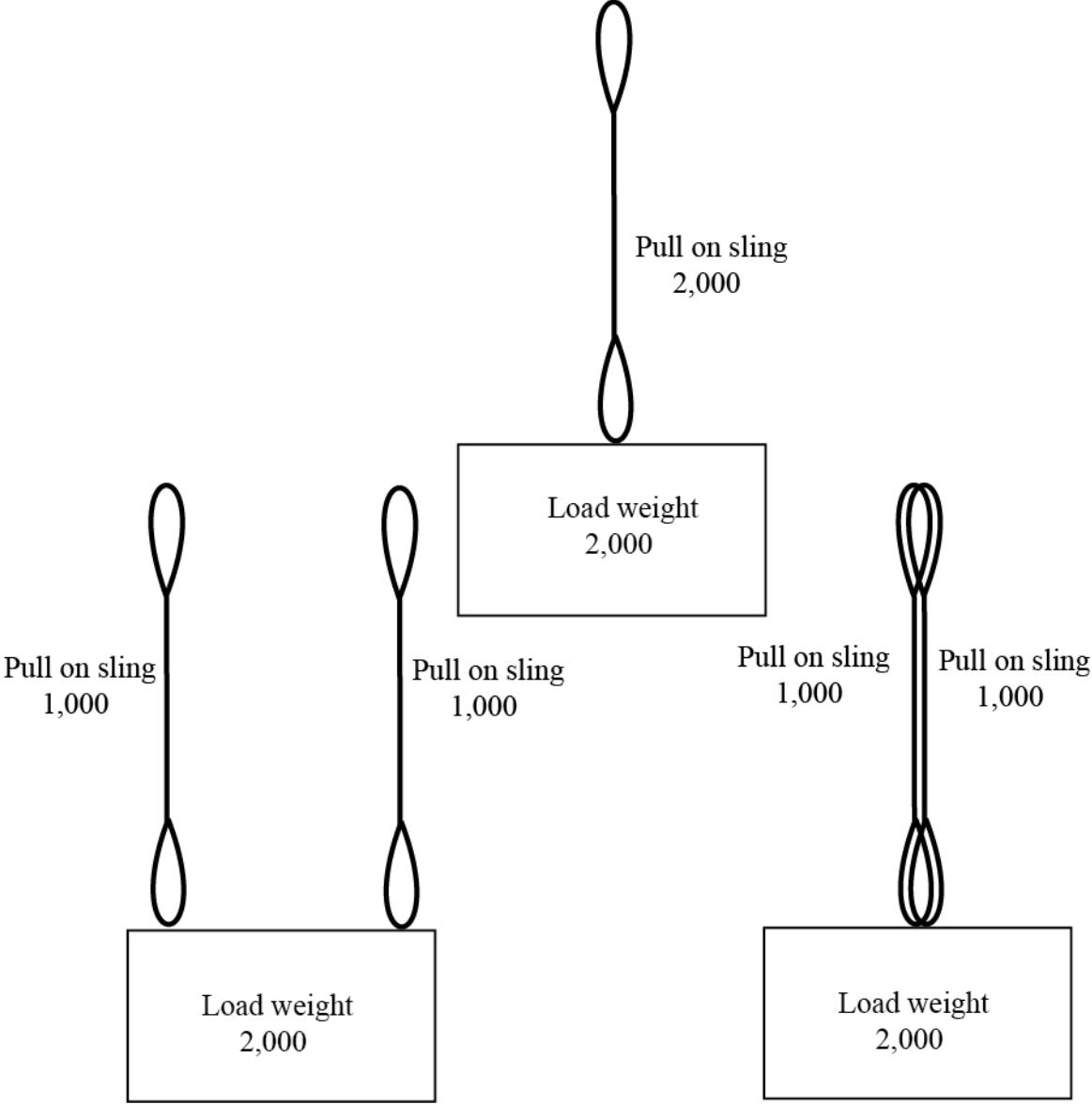

HITCHING AND SLING LOADING

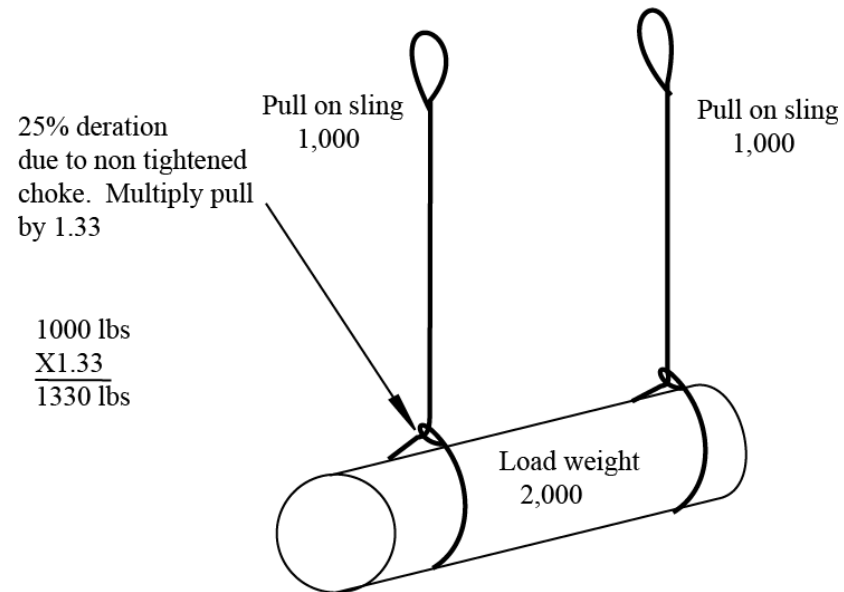
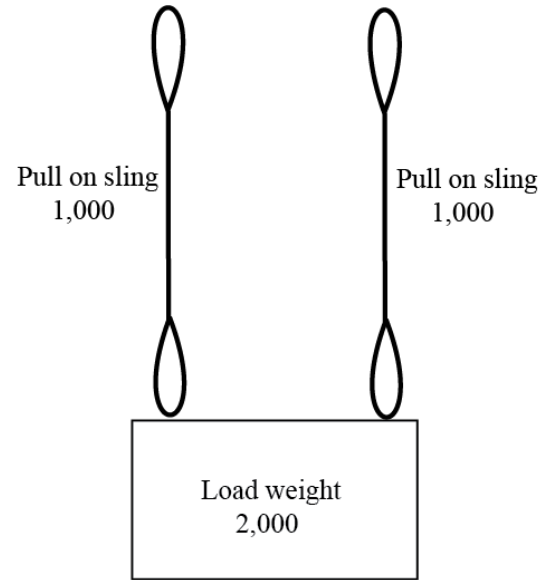

HITCHING CONFIGURATION AND SLING LOADING CONSIDERATIONS

BRIDAL HITCH

The bridal hitch provides a balanced method for lifting a load. This hitch also will distribute the load equally to the of slings. The main consideration for the rigger in this type of configuration is determining sling tension. The tension will increase as the sling angle increases.

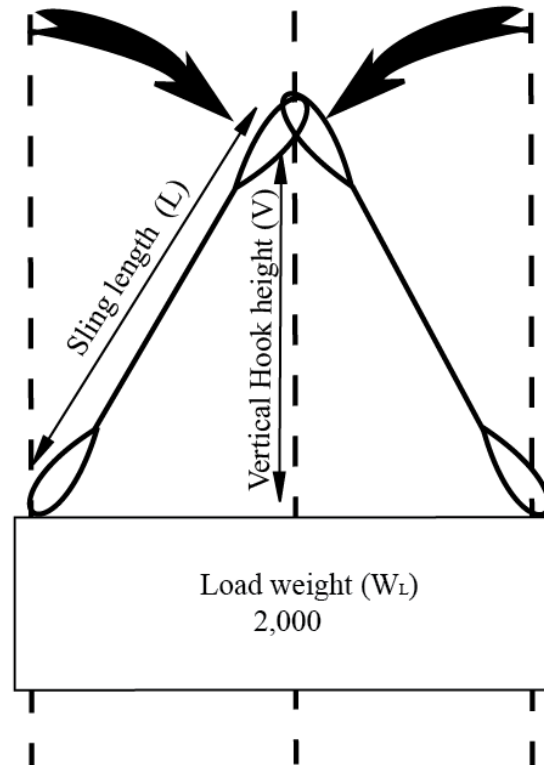

HITCHING CONFIGURATION AND SLING LOADING CONSIDERATIONS

BRIDAL HITCH

The bridal hitch provides a balanced method for lifting a load. This hitch also will distribute the load equally to the two slings. The main consideration for the rigger in this type of configuration is determining sling tension. The tension will increase as the sling angle increases.

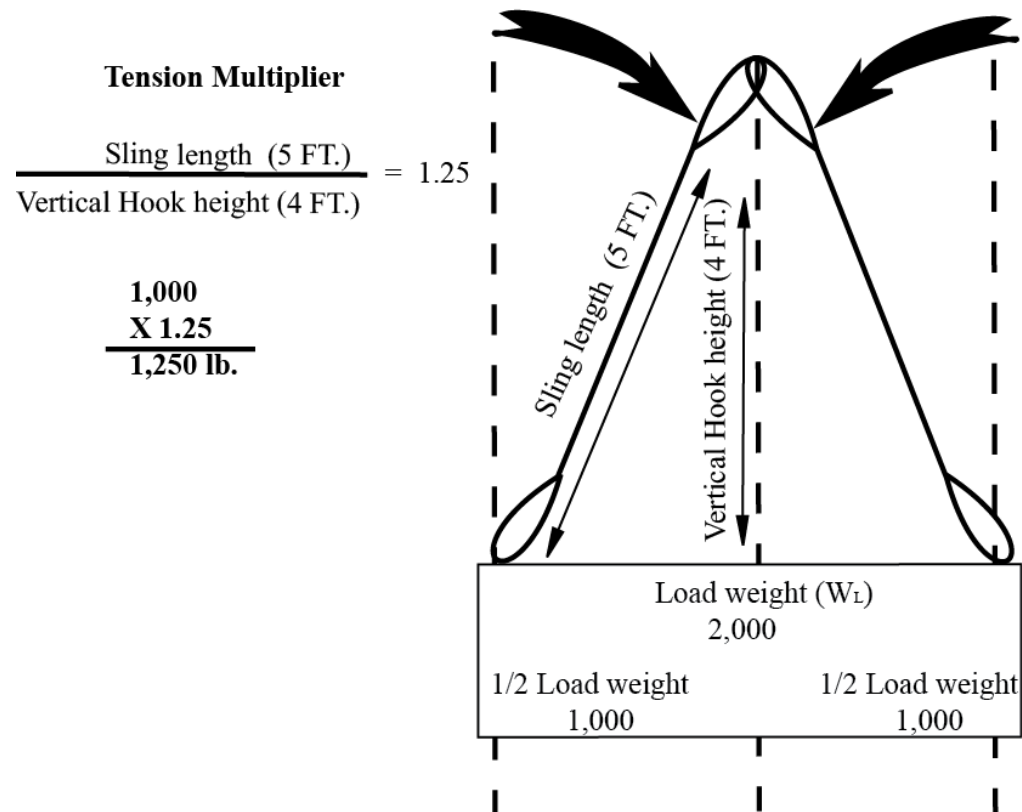

HITCHING CONFIGURATION AND SLING LOADING CONSIDERATIONS

BRIDAL HITCH

The main consideration for the rigger in this type of configuration is determining sling tension. The tension will increase as the sling angle increases. Using the sling length and the load dimensions, figure the hook height.

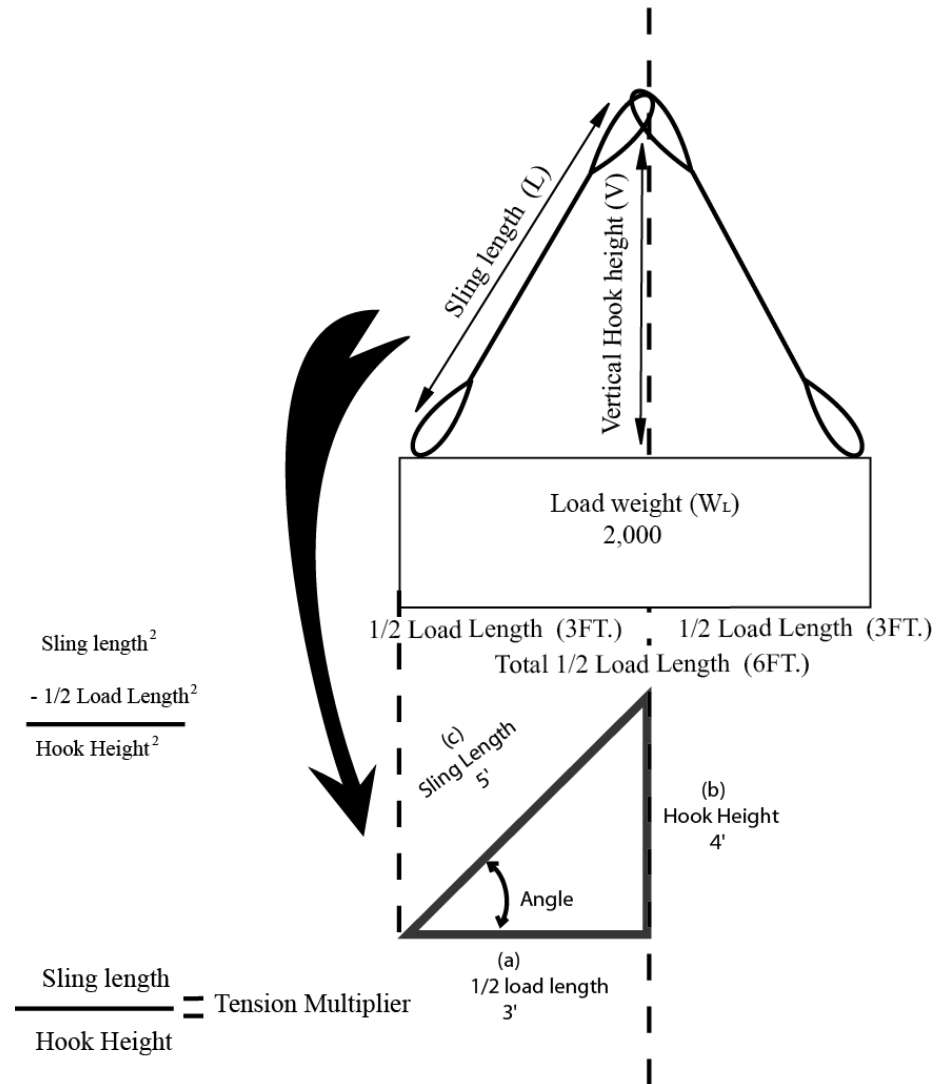

HITCHING CONFIGURATION AND SLING LOADING CONSIDERATIONS

BRIDAL HITCH

The main consideration for the rigger in this type of configuration is determining acceptable sling tension.

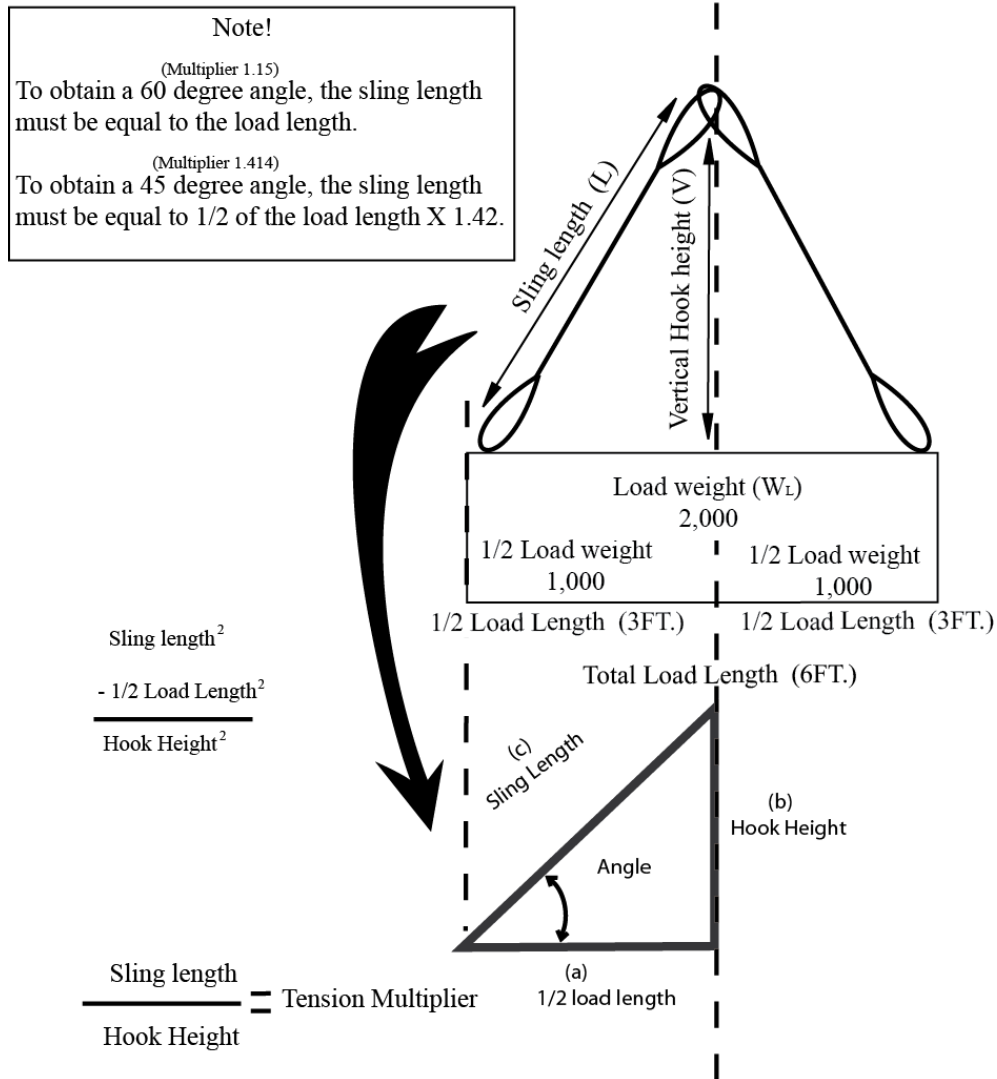

HITCHING CONFIGURATION
AND SLING LOADING CONSIDERATIONS
CHOKED BRIDAL HITCH

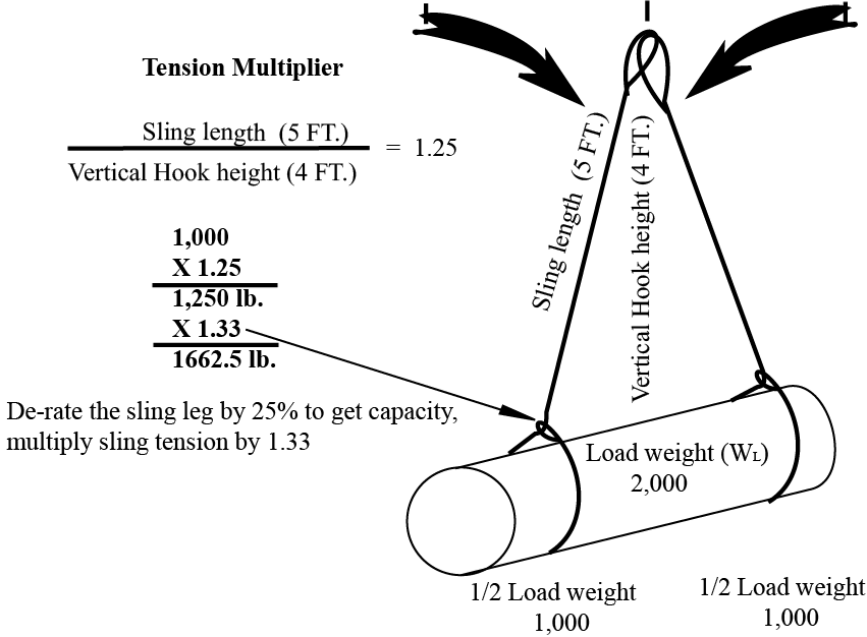
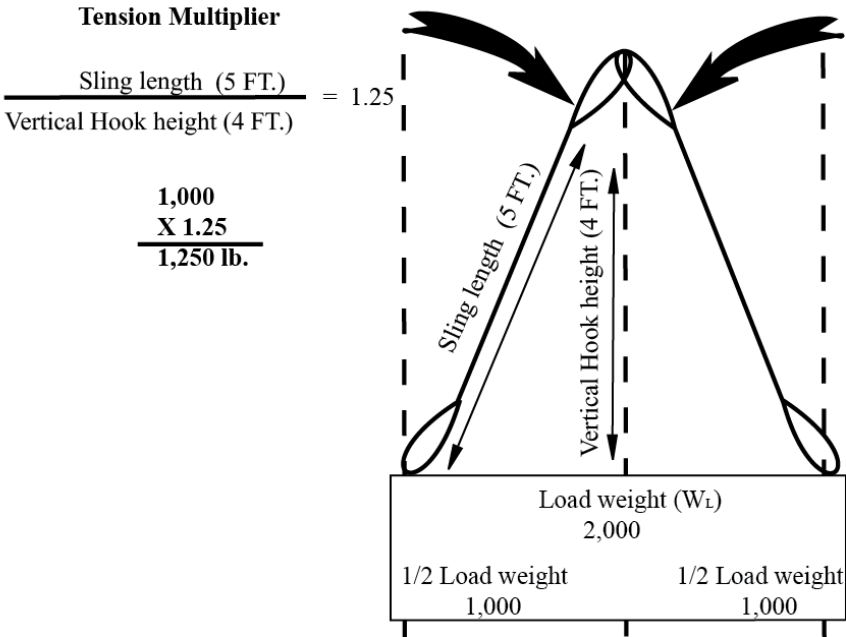

HITCHING CONFIGURATION
AND SLING LOADING CONSIDERATIONS

PULLED CHOKED BRIDAL HITCH
(UNDER 45 DEGREES)

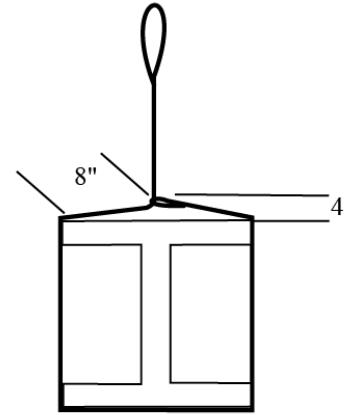

14"
Load weight
840 lb.

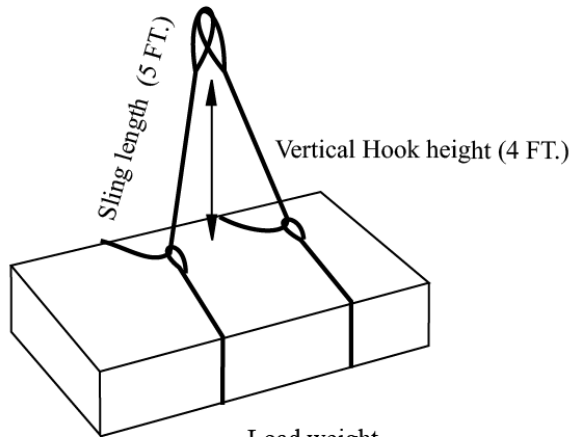

Load weight
2,000

$$\frac{\text{Sling length}}{\text{Hook height}} = \text{Multiplier } \frac{5}{4} = 1.25$$

$$\begin{array}{r} 1000 \text{ lb.} \\ \times 1.25 \\ \hline 1250 \text{ lb.} \\ \times 3 \\ \hline 3750 \text{ lb.} \end{array}$$

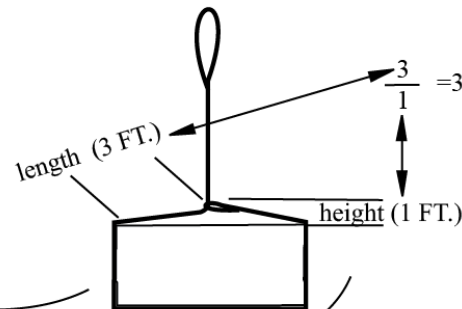

$$\frac{3}{1} = 3$$

GENERAL OSHA REGULATIONS 1910.184

(c)

Safe operating practices. Whenever any sling is used, the following practices shall be observed:

(c)(1)

Slings that are damaged or defective shall not be used.

(c)(2)

Slings shall not be shortened with knots or bolts or other makeshift devices.

(c)(3)

Sling legs shall not be kinked.

(c)(4)

Slings shall not be loaded in excess of their rated capacities.

(c)(5)

Slings used in a basket hitch shall have the loads balanced to prevent slippage.

(c)(6)

Slings shall be securely attached to their loads.

(c)(7)

Slings shall be padded or protected from the sharp edges of their loads.

(c)(8)

Suspended loads shall be kept clear of all obstructions.

(c)(9)

All employees shall be kept clear of loads about to be lifted and of suspended loads.

(c)(10)

Hands or fingers shall not be placed between the sling and its load while the sling is being tightened around the load.

(c)(11)

Shock loading is prohibited.

(c)(12)

A sling shall not be pulled from under a load when the load is resting on the sling.

INSPECTIONS

(d)

Inspections. Each day before being used, the sling and all fastenings and attachments shall be inspected for damage or defects by a competent person designated by the employer. Additional inspections shall be performed during sling use, where service conditions warrant. Damaged or defective slings shall be immediately removed from service.

HARDWARE SHACKLES AND HOOKS

WIRE ROPE SHACKLES AND HOOKS

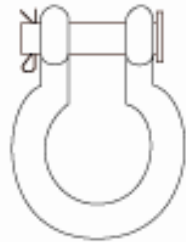

Round Pin
Shackle
Do not use in rigging!



Screw Pin
Shackle

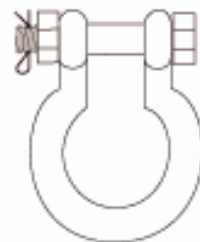

Bolt Type
Shackle

WEB SLING SHACKLES AND HOOKS

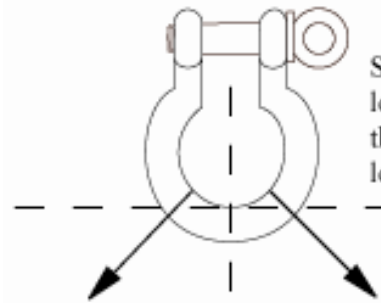

Shackles are designed for vertical loading, if an angle exists consult the shackle manufacturer as to safe load angles.

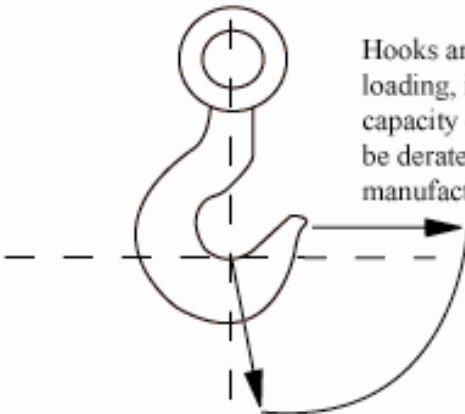

Hooks are designed for vertical loading, if load is not vertical the capacity of the hook will have to be derated. Consult the hook manufacturer for this information.

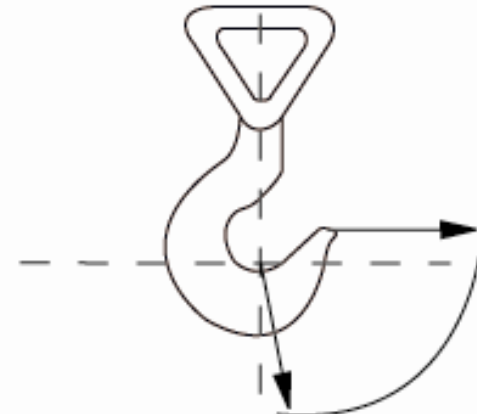
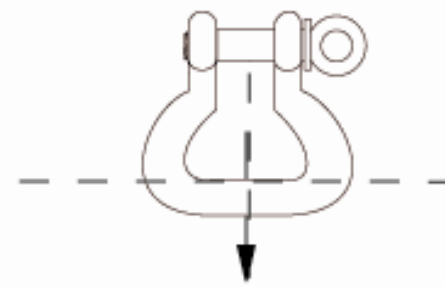

HARDWARE SHACKLES AND HOOKS

Inspect shackles for damage. If damage is discovered the shackle must be removed from service.
DO NOT exchange or substitute any shackle components!

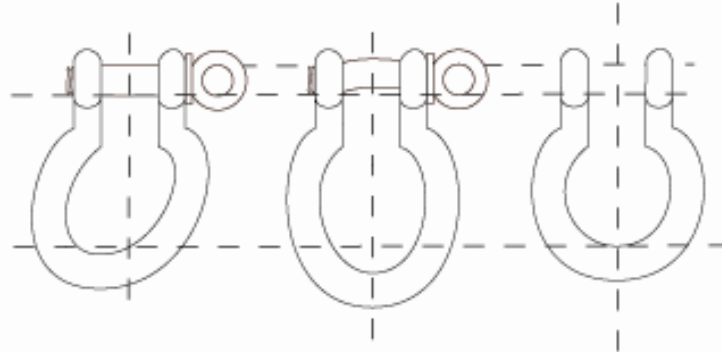

DO
Apply the load in
a vertical direction

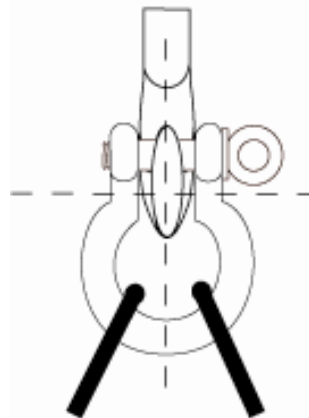

DO NOT
Side load
a shackle



Inspect hooks for damage. If damage is discovered the hook must be removed from service!

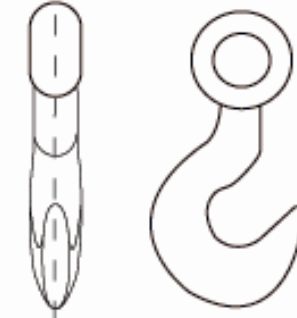
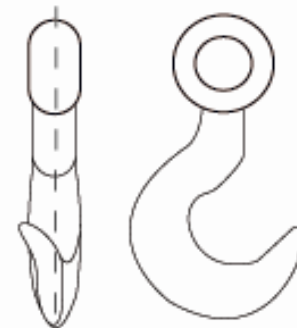

COMMON SYNTHETIC SLING DAMAGE



Damage from
Unprotected Edges



Chemical
Damage



Abrasion
Damage



Burn
Damage



Overload
Break

ONLY USE MANUFACTURERS SPECIFICATIONS

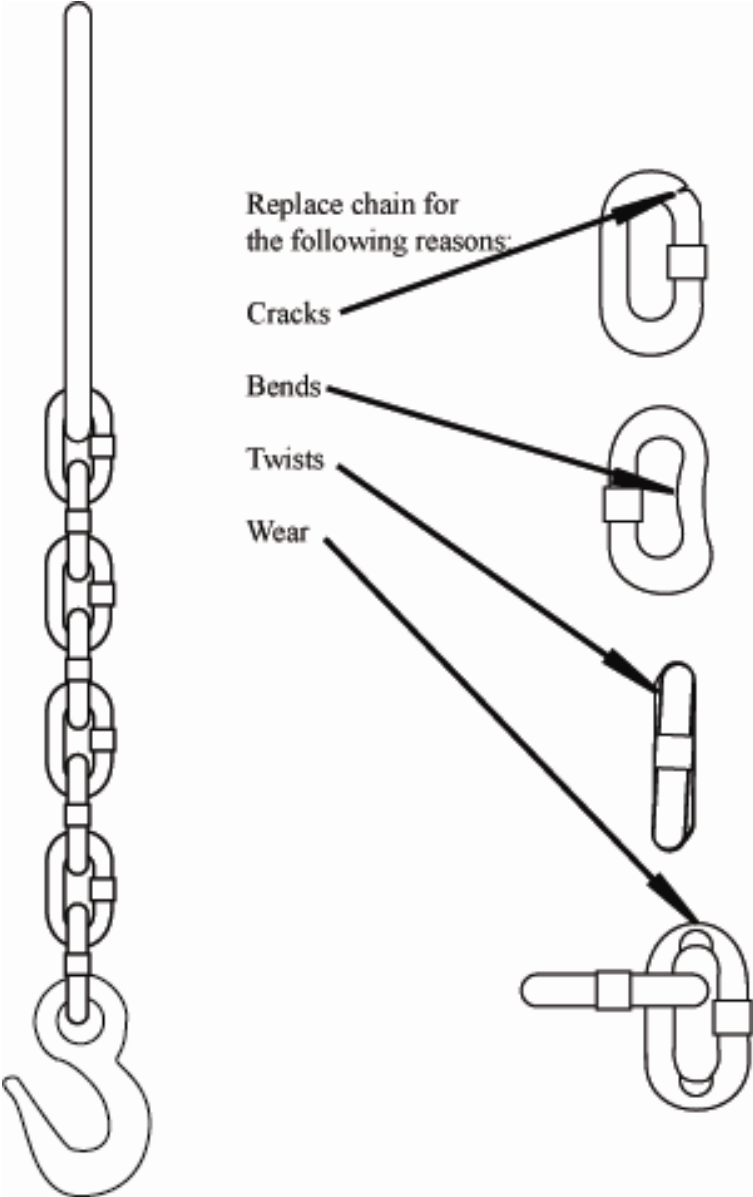

THANK YOU